

LANCASTER

GENERAL WM J FOX AIRFIELD (WJF)(KWJF) 4 NW UTC-8(-7DT) N34°44.46' W118°13.12' **LOS ANGELES**
 2351 B TPA—3151(800) NOTAM FILE WJF **H-4I, L-3E, 4G, 7B**
RWY 06-24: H7201X150 (ASPH-RFSC) S-50, D-68, 2S-86, 2D-117 **IAP, AD**

MIRL

RWY 06: REIL. PAPI(P4L)—GA 3.0° TCH 40'.

RWY 24: REIL. PAPI(P4L)—GA 3.0° TCH 40'. Rgt tfc.

SERVICE: S4 FUEL 100LL, JET A OX2

AIRPORT REMARKS: Attended continuously. Lgtd radio twrs 4 miles SE.

Numerous birds SE of arpt. PAEW adjacent ramp area between fuel island and terminal bldg.

AIRPORT MANAGER: 661-940-1709

WEATHER DATA SOURCES: ASOS (661) 949-2840

COMMUNICATIONS: CTAF 118.525 ATIS 126.3 UNICOM 122.95

® **JOSHUA APP/DEP CON** 126.1

FOX TOWER 118.525 (1500-0500Z±) **GND CON** 121.7

AIRSPACE: CLASS D svc 1500-0500Z±; other times CLASS E.

RADIO AIDS TO NAVIGATION: NOTAM FILE PMD.

PALMDALE (H) VORTACW 114.5 PMD Chan 92 N34°37.88'

W118°03.83' 296° 10.1 NM to fld. 2498/15E. unmonitored when ATCT clsd.

VOR unusable:

010°-020°

110°-160° byd 35 NM blo 11,600'

160°-235° byd 30 NM blo 8,100'

TACAN AZIMUTH unusable:

110°-145° byd 20 NM blo 15,500'

145°-235° byd 20 NM blo 14,500'

345°-355° byd 35 NM

DME unusable:

120°-145° byd 20 NM blo 15,500'

145°-150° byd 20 NM blo 14,500'

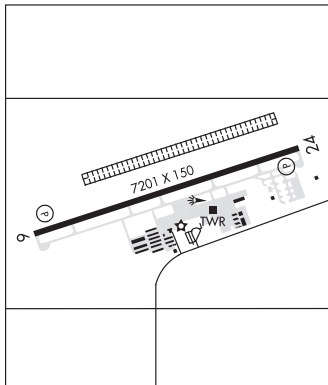

LEE VINING (O24) 1 E UTC-8(-7DT) N37°57.46' W119°06.35'

SAN FRANCISCO

6802 B TPA—7602(800) NOTAM FILE RAL

L-9A

RWY 15-33: H3920X60 (ASPH) S-30 LIRL 0.9% up SE

RWY 33: Rgt tfc.

SERVICE: LGT ACTIVATE LIRL Rwy 15-33—CTAF.

AIRPORT REMARKS: Unattended. NSTD dsplcd thld markings are yellow.

AIRPORT MANAGER: 760-932-5452

COMMUNICATIONS: CTAF 122.9

CLEARANCE DELIVERY PHONE: For CD ctc Oakland ARTCC at 510-745-3380.

RADIO AIDS TO NAVIGATION: NOTAM FILE BIH.

BISHOP (T) VOR/DME 109.6 BIH Chan 33 N37°22.62' W118°21.99' 300° 49.5 NM to fld. 4117/15E.

VOR/DME unusable:

360°-105° byd 18 NM