

APP CRS 276°	Rwy Idg 4298
	TDZE 813
	Apt Elev 818

RNAV (GPS) RWY 28

IONIA COUNTY (Y70)

RNP APCH - GPS.	MISSED APPROACH: Climb to 3000 direct IJHUH and hold.
Circling NA to Rwy 18 and 36. Rwy 28 helicopter visibility reduction below 3/4 SM NA.	

AWOS-3 118.9	GREAT LAKES APP CON ★ 118.65 226.4	UNICOM 122.8 (CTAF)
------------------------	--	-------------------------------

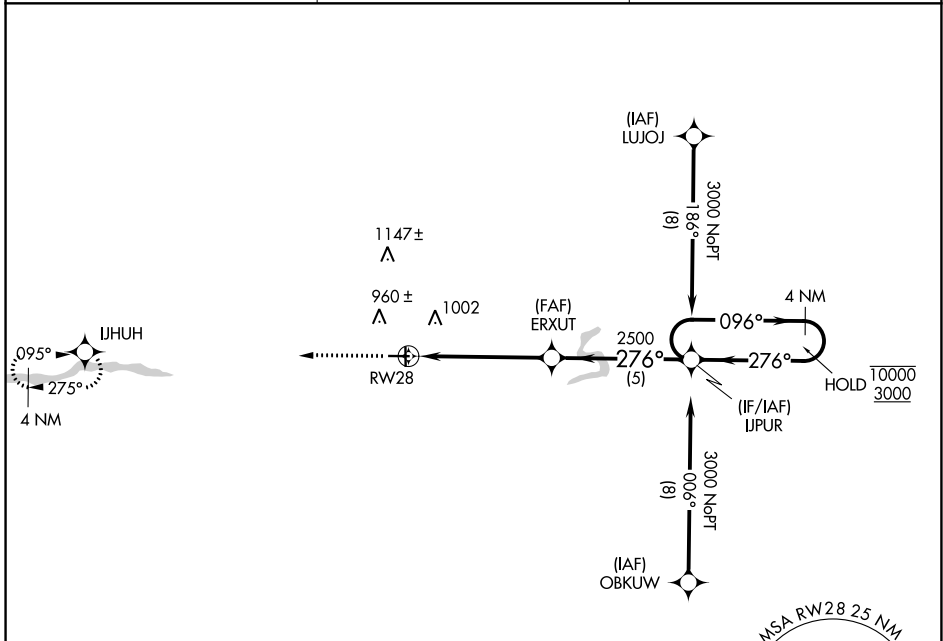

ELEV 818	TDZE 813
----------	----------

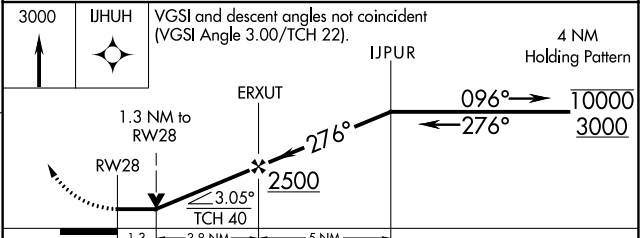
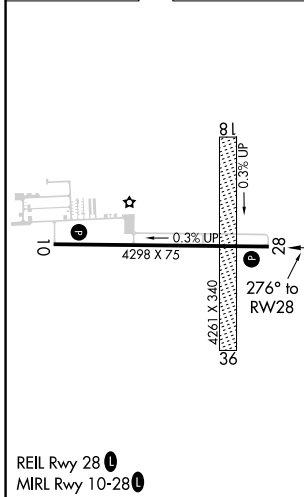

CATEGORY	A	B	C	D
LNAV MDA	1240-1	427 (500-1)	1240-1 1/4 427 (500-1 1/4)	NA
CIRCLING	1320-1	502 (600-1)	1340-1 1/2 522 (600-1 1/2)	NA

EC-1, 07 SEP 2023 to 05 OCT 2023

EC-1, 07 SEP 2023 to 05 OCT 2023